

Specifications

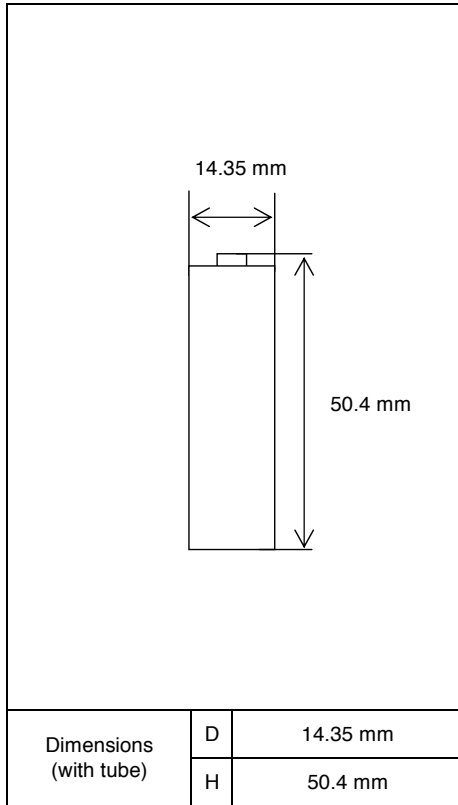

Type : Nickel-Metal Hydride Battery		Size : AA Consumer Type
Capacity ¹⁾	Typical	1000mAh
	Minimum	950mAh
Nominal Voltage		1.2V
Charging Current x Time	Fast Charge ²⁾	1000mA × 1.1h
Ambient Temp.	Charge Condition	Fast Charge ²⁾
	Discharge Condition	0°C - 40°C
	Storage Condition	0°C - 50°C
	Less than 90days	-20°C - 40°C
	Less than 1year	-20°C - 30°C
Internal Impedance ³⁾ (after discharge to E.V.=1.0V)		Approx. 25mΩ (at 1000Hz)
Weight ⁴⁾		Approx. 19g
Size ⁴⁾ : (Diameter) x (Height)		14.35(D) x 50.4(H) mm

- 1) Single cell capacity under the following condition.
Charge : 100mA×16h, Discharge : 200mA(E.V.=1.0V) at 20°C
- 2) Use recommended charging system.
- 3) After a few charge and discharge cycles under the above 1) condition.
- 4) With tube.

Typical Characteristics

Charge

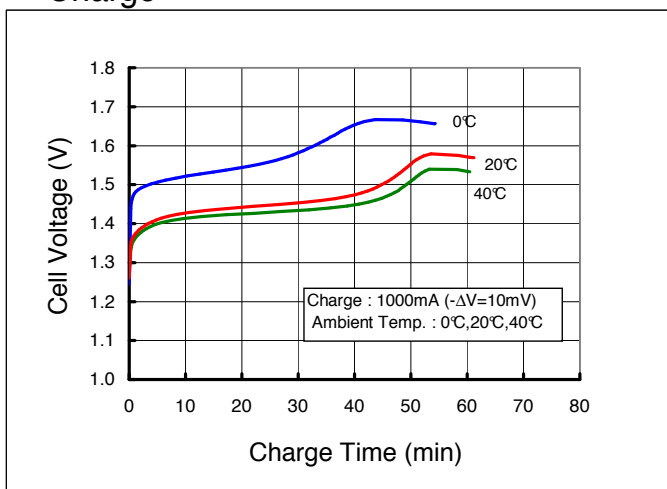

Discharge

